

External Dimensions (mm)

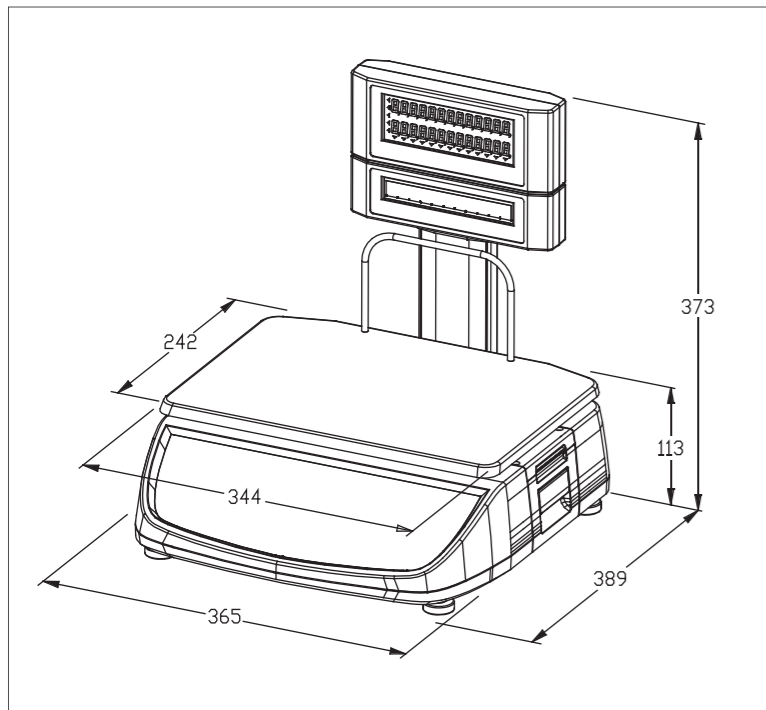

Customer Display



RM-60

Scale Receipt Printer

Weighing and receipt printing anywhere



Basic Specifications

Capacity	3/6kg 1/2g	6/15kg 2/5g	15/30kg 5/10g
Model	RM-60		
Display	26 digits x 9 segments TN type LCD with backlight for numeric digit display, for both operator and customer side. 176 x 16 dots TN type LCD with backlight for character display, for operator side and customer side as option.		
Number of Preset Keys	24		
Display Resolution	1/3000		
Paper Width	48mm		
Printing Speed	Maximum 75 mm / sec		
Power Source	AC 240/230/220V, 117/100V (+10%, -15%) <small>Factory option</small> DC 12V 5Ah rechargeable battery (optional)		
Operating Temperature	-10 ~ +40 (OIML)		
Standard Interface	AC receptacle. Cash drawer control port (drive voltage is 8V). 2 x RS-232 ports. USB 1.1 and USB 2.0 full speed (12 Mbps) host port. 10M/100M Ethernet port.		
Platter Size	344(W) x 242(D) mm		
Overall Size	365(W) x 389(D) x 113(373)(H) mm		

*Equips rechargeable battery as backup power source for 44 hours of functioning continuous usage without printing, or 4 - 5 rolls (diameter = 50mm) of receipts printing. (Back-light function is off).

*Specifications are subject to change without prior notice.



TERAOKA SEIKO CO., LTD.

13-12 Kugahara 5-chome, Ohta-ku,
Tokyo 146-8580, JAPAN
TEL: +81-3-3752-2131
FAX: +81-3-3752-2801
URL: <http://www.digisystem.com>
E-MAIL: info@hq.digi.co.jp

TERAOKA WEIGH-SYSTEM PTE LTD.

4, Leng Kee Road, #06-01, SIS Building,
SINGAPORE 159088
TEL: +65-6861-3911
FAX: +65-6861-3144

SHANGHAI TERAOKA ELECTRONIC CO., LTD.

TINGLIN INDUSTRY DEVELOPMENTAL ZONE,
JINSHAN COUNTY, SHANGHAI 201505
TEL: +86-21-57234888
FAX: +86-21-57233049
<http://www.digisystem.com>

Searching for
a New Balance



8 Features of RM-60

RM-60: designed for weighing and cash control in the open retail market.
Backed by years of experience at DIGI the RM-60 helps your operation by delivering superb value!

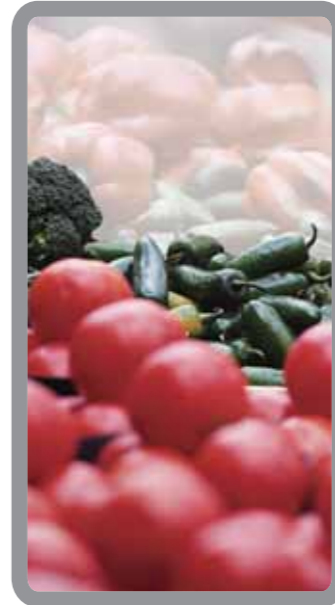
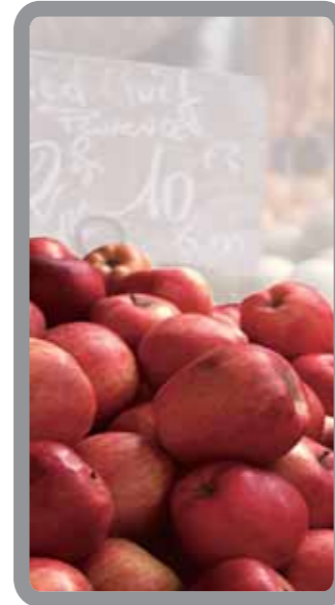
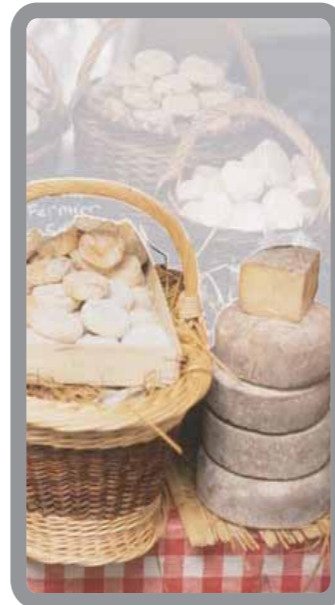
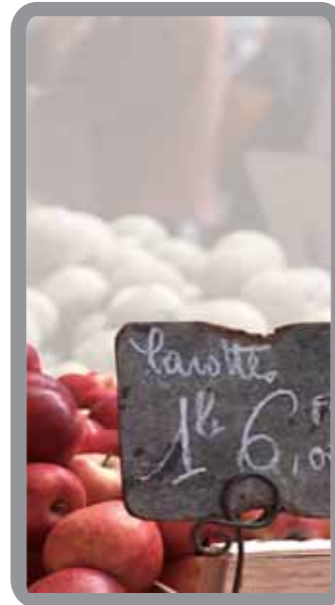

1 Receipt Printing

High-speed thermal printer is built in for receipt printing. Easy paper handling is achieved with a simple loading mechanism. Store name and message can be printed on the receipt.

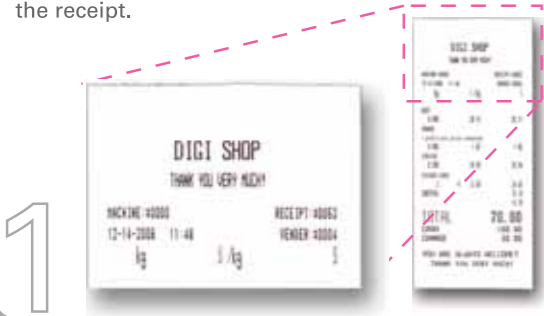

2 Barcode Reader

Scan non-weighing items with the optional barcode reader.



3 Cash Box

Complete transactions with the optional cash box.



4 Operate Under Direct Sunshine

Display data is clearly visible even in harsh sunlight with the reflective type high-contrast LCD.



5 Connection to USB Mass Storage Device

Control prices and data easily through the USB mass storage device connection.



6 Work All Day Without Recharging

Over 12 hours of normal operation for weighing and receipt printing are now possible with the built-in battery.

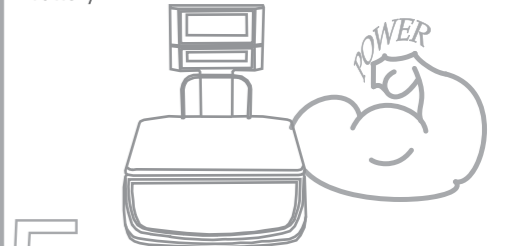

*Please refer to the specification in the back page. (Built-in Battery is optional.)

7 Fast Weighing & Stable Display

Designed to weigh quickly and maintain a stable display even in the outdoors.



8 Strong Cash Management

Manage digital price computing and the electronic cash register together with inventory control for weighing item and non-weighing item with opening balance, sales and closing balance and physical counting.

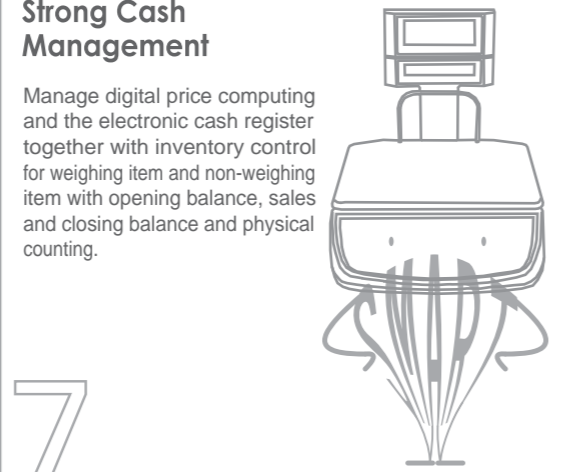

9 Scale Network

Through the standard Ethernet, inter-scale and store controller communication is readily available. Optional: Wireless LAN (802.11b/g/n).

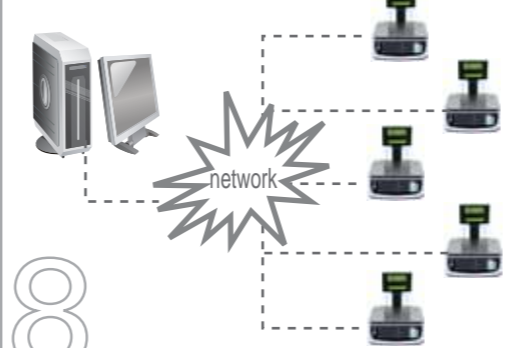

10 Can be connected

